

ARMARIO CON 2 PUERTAS ABATIBLES Y 6 ESTANTES
EXTRAÍBLES CON TAPA DE POLICARBONATO
TRANSPARENTE, DIM. 1400X800X2400+300Hmm

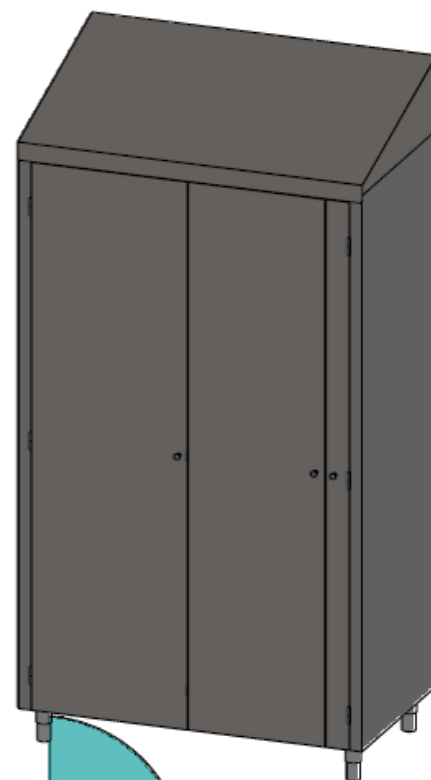

Fabricado en acero inoxidable AISI 304 2B Ni-Cr 18/10 con acabado exterior Scotch Brite. Puertas abatibles montadas sobre bisagras desmontables sin necesidad de herramientas mecánicas, cierre magnético. Completo con 6 estantes de 300mm de altura, montadas sobre guías telescópicas desmontables de acero inoxidable y con tapa abatible de policarbonato transparente. Preparado para montaje en pared. Pies telescópicos de acero inoxidable. Techo inclinado H=300mm.

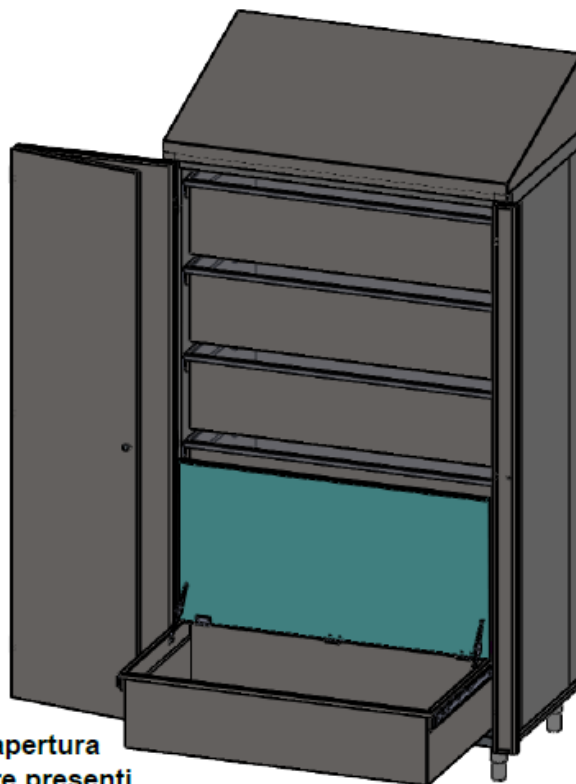
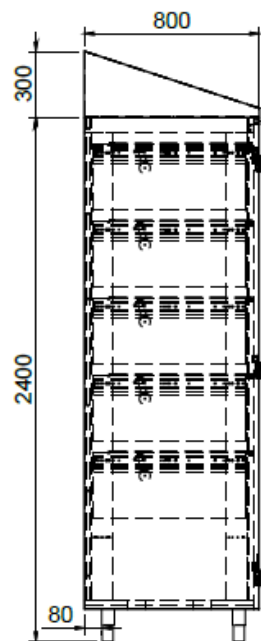
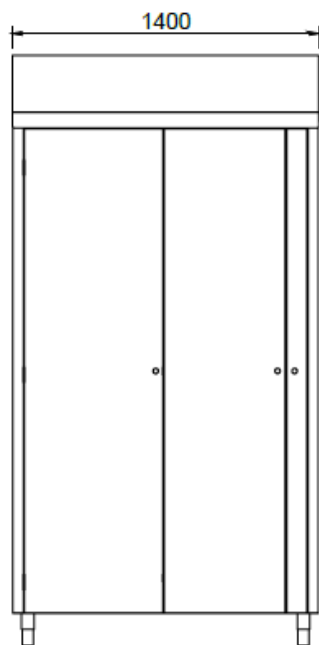

nuove ante con doppia apertura
con utilizzo delle cerniere presenti

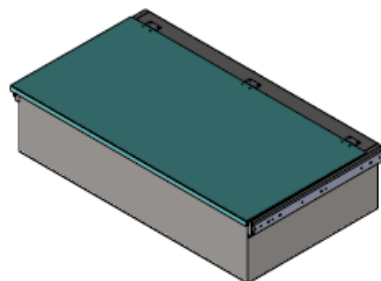
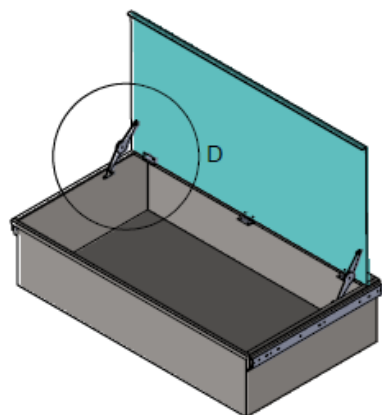

sistema di supporto
a compasso

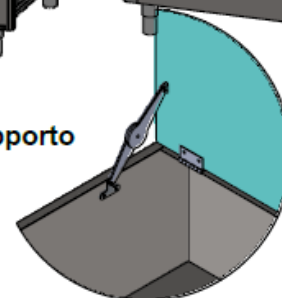

DETTAGLIO D
SCALA 2 : 25



Tolleranza generale: dimensioni:	UNI ISO 2768-mk		Scala:	1:30	Peso:	424,694 kg
			Materiale:			
			Sviluppo:		x x	
			Trattamento:			

Serie:	Codice articolo:	Codice cliente:
Descrizione: ARMADIO CON 2 ANTE BATTENTI E 6 RIPIANI A VASCHETTA SU GUIDE TELESCOPICHE ESTRAIBILI CON COPERCHIO IN LEXAN TRASPARENTE, DIM. 1400X800X2400+300h/mm		Codice: TS22000341-000A
		Rev.